

Data Sheet

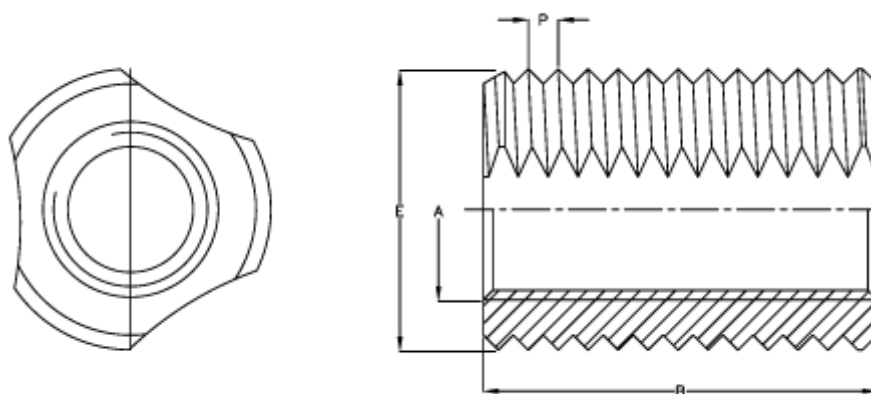

Article number: 12305000030800
Description: KLEE-coil 305 000 030.800
M3 Brass

Measures



Female thread A	= M3
Length B	= 6
Male thread E	= 5.0
Min hole depth blind hole	= 7
Recommended bore diameter	= 4.6 to 4.7
Thread pitch P	= 0.50
Type	= 305 000 030.800